

# VERTICAL SECTION

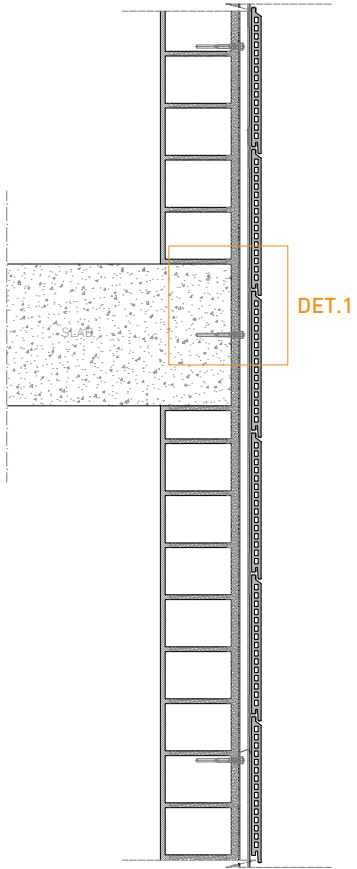

DET.1

# HORIZONTAL SECTION

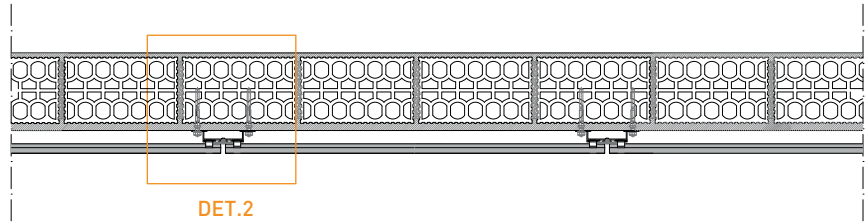

DET.2

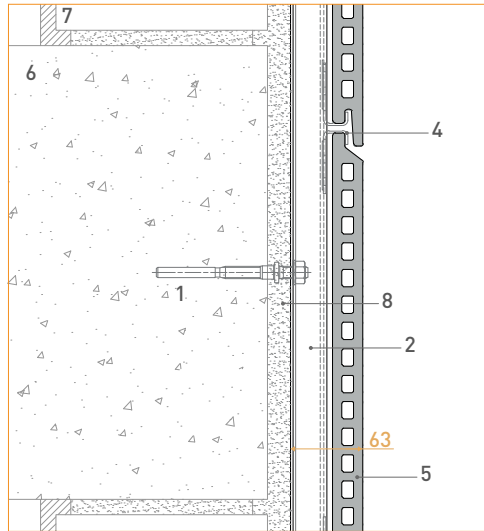

1. Support bracket

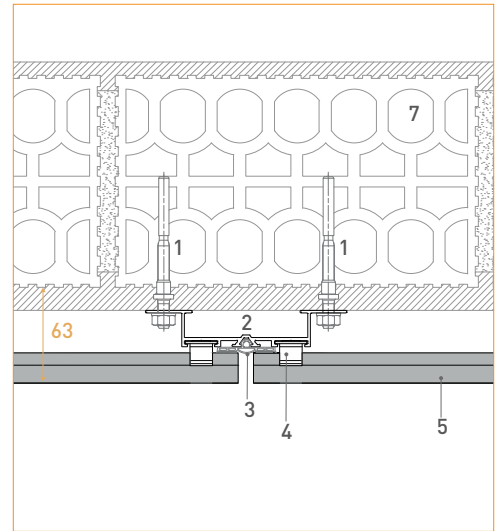

2. Horizontal detail

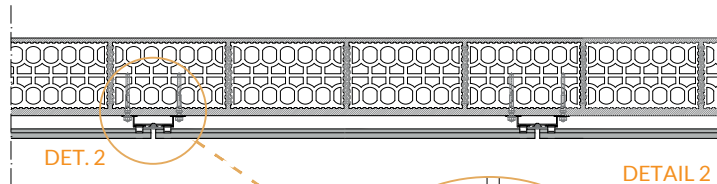

**HORIZONTAL SECTION**

scale: 1/8

**LEGEND:**

- 1. PLASTIC ANCHOR
- 2. OMEGA ALUMINUM VERTICAL PROFILE (PFC)
- 3. EPDM
- 4. CLIP 15 mm
- 5. FAVETON CERAMIC TILE
- 6. SLAB
- 7. WALL

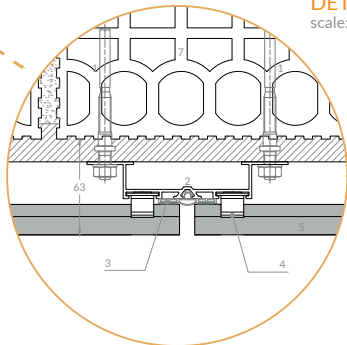

**DETAIL 2**  
scale: 1/2.5

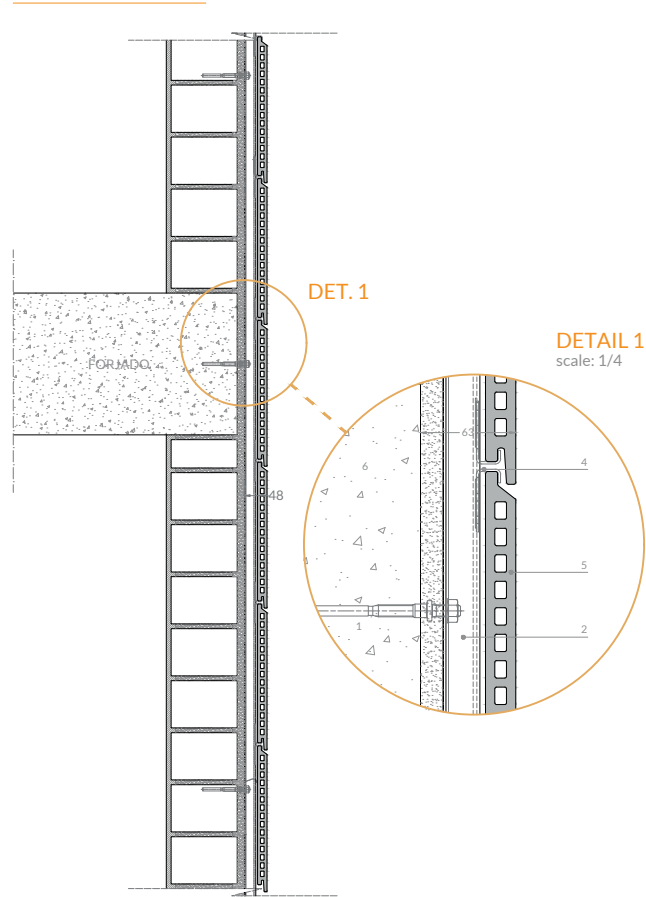

**DET. 1**

**DETAIL 1**  
scale: 1/4